

Powered by



# GP 6120 ▶ 6V 12Ah

GP 6120 is a general purpose battery up to 5 years in standby service or more than 260 cycles at 100% discharge in cycle service. As with all CSB batteries, all are rechargeable, highly efficient, leak proof and maintenance free.



## ► Specification

Cells Per Unit	3
Voltage Per Unit	6
Capacity	12A h @ 20hr-rate to 1.75V per cell @25°C (77°F)
Weight	Approx. 1.85 kg(4.08 lbs)
Maximum Discharge Current	150A/180A(5sec)
Internal Resistance	Approx. 8.5 mΩ
Operating Temperature Range	Discharge: -15°C~50°C ( 5°F~122°F) Charge: -15°C~40°C ( 5°F~104°F) Storage: -15°C~40°C ( 5°F~104°F)
Nominal Operating Temperature Range	25°C±3°C (77°F±5°F)
Float Charging Voltage	6.75 to 6.9 VDC/unit Average at 25°C (77°F)
Recommended Maximum Charging Current Limit	3.6A
Equalization and Cycle Service	7.2 to 7.5 VDC/unit Average at 25°C (77°F)
Self Discharge	CSB Batteries can be stored for more than 6 months at 25°C (77°F). Please charge batteries before using. For higher temperatures the time interval will be shorter.
Terminal	F1/F2-Faston Tab187/250
Container Material	ABS(UL 94-HB) & Flammability resistance of (UL 94-V0) can be available upon request.



CSB-manufactured **VRLA** (Absorbent Glass Mat type) batteries are UL-recognized components under UL1989.

CSB is also certified by ISO 9001 and ISO 14001.

Dimensions :	Overall Height (H)	Container height (h)	Length (L)	Width (W)
Unit: mm (inch)	100±1 (3.94±0.04)	94±1 (3.7±0.04)	151±2 (5.94±0.08)	50±1 (1.97±0.04)

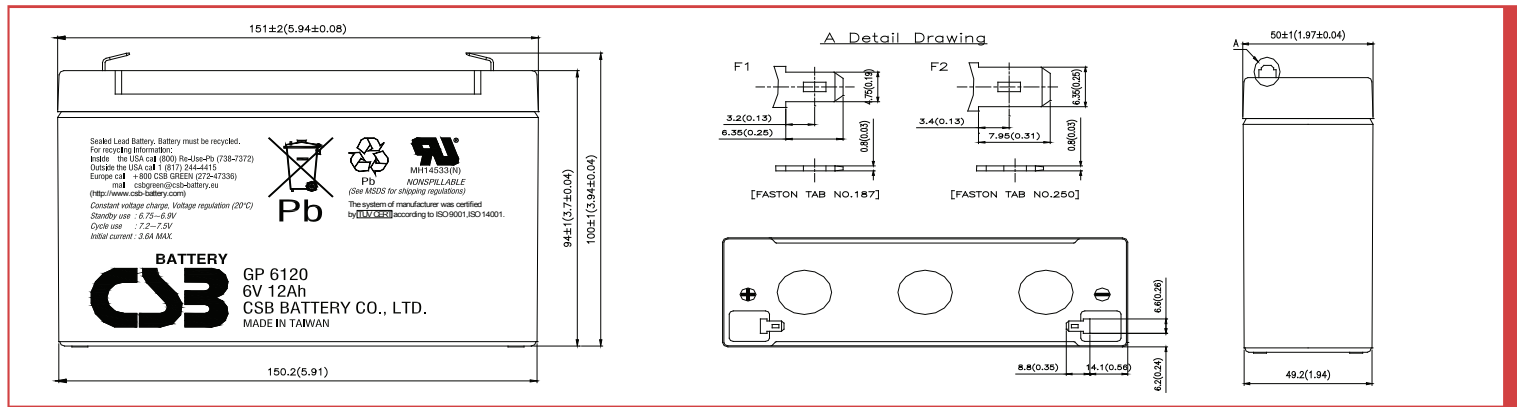

## Constant Current Discharge Characteristics Unit:A (25°C,77°F)

F.V/Time	5MIN	10MIN	15MIN	30MIN	60MIN	90MIN	2HR	3HR	5HR	8HR	10HR	20HR
1.60V	51.2	33.2	23.9	13.9	8.14	5.90	4.69	3.37	2.24	1.45	1.19	0.62
1.67V	48.2	32.0	23.6	13.7	8.12	5.84	4.62	3.35	2.21	1.44	1.18	0.61
1.70V	46.3	31.6	23.3	13.6	8.08	5.82	4.61	3.32	2.18	1.43	1.17	0.61
1.75V	43.3	30.0	22.6	13.4	8.03	5.77	4.57	3.26	2.13	1.40	1.15	0.61
1.80V	38.8	28.0	21.5	13.0	7.81	5.64	4.48	3.17	2.06	1.37	1.14	0.59
1.85V	34.2	25.3	19.8	12.3	7.51	5.41	4.29	3.03	1.97	1.32	1.09	0.57

## Constant Power Discharge Characteristics Unit:W (25°C,77°F)

F.V/Time	5MIN	10MIN	15MIN	30MIN	60MIN	90MIN	2HR	3HR	5HR	8HR	10HR	20HR
1.60V	269	173	134	79.8	48.9	35.3	28.0	19.8	12.7	8.36	6.91	3.85
1.67V	257	171	132	79.6	48.8	35.1	27.8	19.7	12.6	8.30	6.85	3.81
1.70V	250	168	131	78.8	48.5	35.0	27.7	19.5	12.5	8.25	6.80	3.80
1.75V	231	163	128	78.1	48.1	34.6	27.5	19.3	12.2	8.12	6.69	3.77
1.80V	209	153	121	76.3	47.4	34.0	26.8	18.9	12.0	7.91	6.52	3.71
1.85V	185	140	111	72.2	45.8	33.1	26.3	18.1	11.7	7.73	6.36	3.61

Ratings presented herein are subject to revision without notice. Please refer to [www.csb-battery.com](http://www.csb-battery.com) to confirm the latest version.

### Trickle (or Float) Service Life

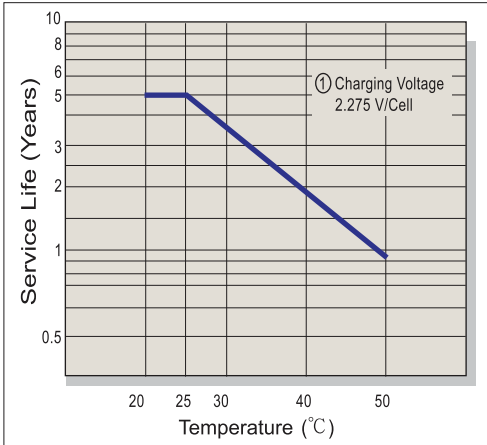

### Capacity Retention Characteristic

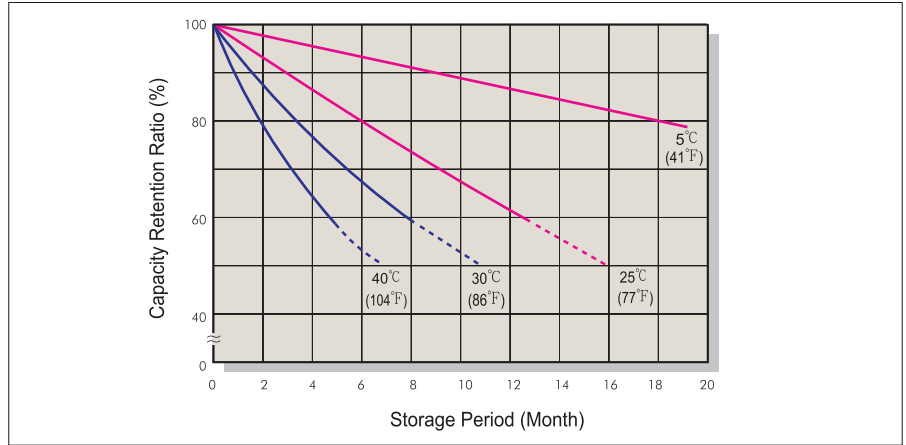

### Battery Voltage and Charge Time for Standby Use

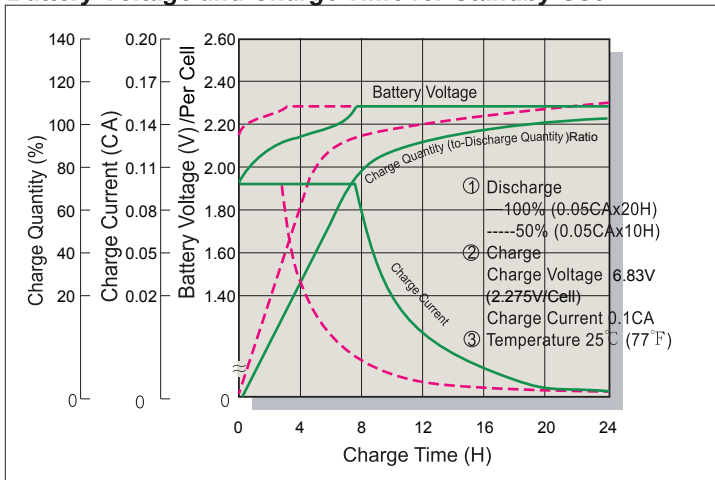

### Cycle Service Life

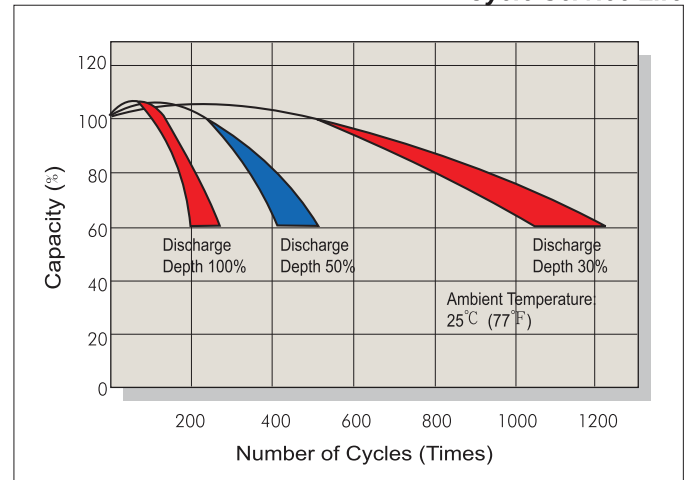

### Battery Voltage and Charge Time for Cycle Use

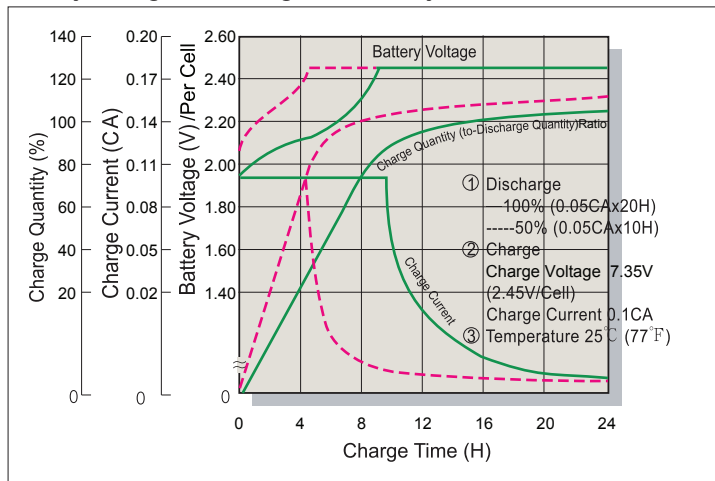

### Terminal Voltage (V) and Discharge Time

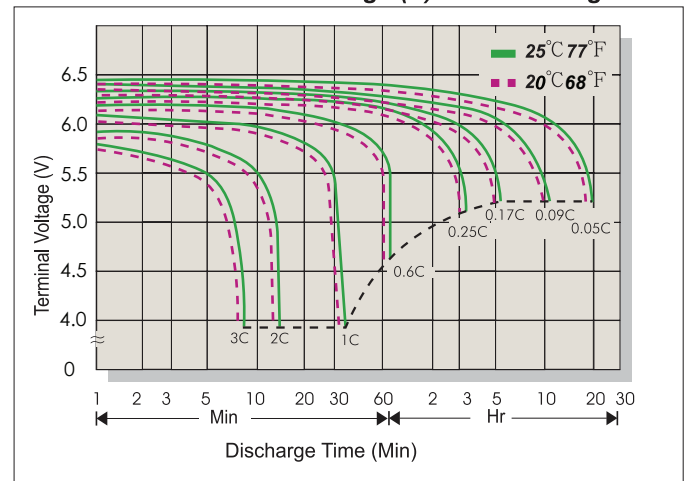

### Charging Procedures

Application	Charge Voltage(V/Cell)			Max.Charge Current
	Temperature	Set Point	Allowable Range	
Cycle Use	25°C (77°F)	2.45	2.40~2.50	0.3C
Standby	25°C (77°F)	2.275	2.25~2.30	

### Discharge Current VS. Discharge Voltage

Final Discharge Voltage V/Cell	1.75	1.70	1.60	1.30
Discharge Current(A)	0.2C>(A)	0.2C<(A)<0.5C	0.5C<(A)<1.0C	(A)>1.0C

Sales Office URL: [WWW.CSB-BATTERY.COM](http://WWW.CSB-BATTERY.COM)

### GLOBAL HQ CSB BATTERY CO., LTD. (TAIWAN)

Tel : +886-2-2880-5600  
Fax : +886-2-2888-3300  
mail : service@csb-battery.com.tw

### BEIJING OFFICE. (CHINA)

CSB BATTERY TECHNOLOGIES (BEIJING) CO., LTD.  
Tel : +86-10-5820-5336/5338  
Fax : +86-10-58203053  
mail : chinasl@csb-battery.com

### AMERICA HQ

CSB BATTERY TECHNOLOGIES INC. (U.S.A)  
Tel : +1-817-244-7777/1-(800)3-CSB-USA(272872)  
Fax : +1-817-244-4445  
mail : csb@csb-battery.com

### SHANGHAI OFFICE. (CHINA)

CSB BATTERY LOGISTIC (SHANGHAI) CO., LTD.  
Tel : +86-21-5046-1622/5046-0833  
Fax : +86-21-5064-1046  
mail : chinasl@csb-battery.com

### EUROPE HQ

CSB Battery Europe BV.  
Tel : +31(0)-180-418-140  
Fax : +31(0)-180-418-327  
mail : eurosales@csb-battery.eu

### SHENZHEN OFFICE. (CHINA)

CSB BATTERY LOGISTIC (SHANGHAI) CO., LTD.  
Tel : +86-755-8831-6488/6396/6356  
Fax : +86-755-8831-6548  
mail : she@csb-battery.com.cn